

Cut and Paste Back to School

Cut out the back to school pictures and paste them into groups on plain paper. List the groups with headings "School Supplies", "Classroom", and "Recess". Paste the school pictures into the correct groups and color.

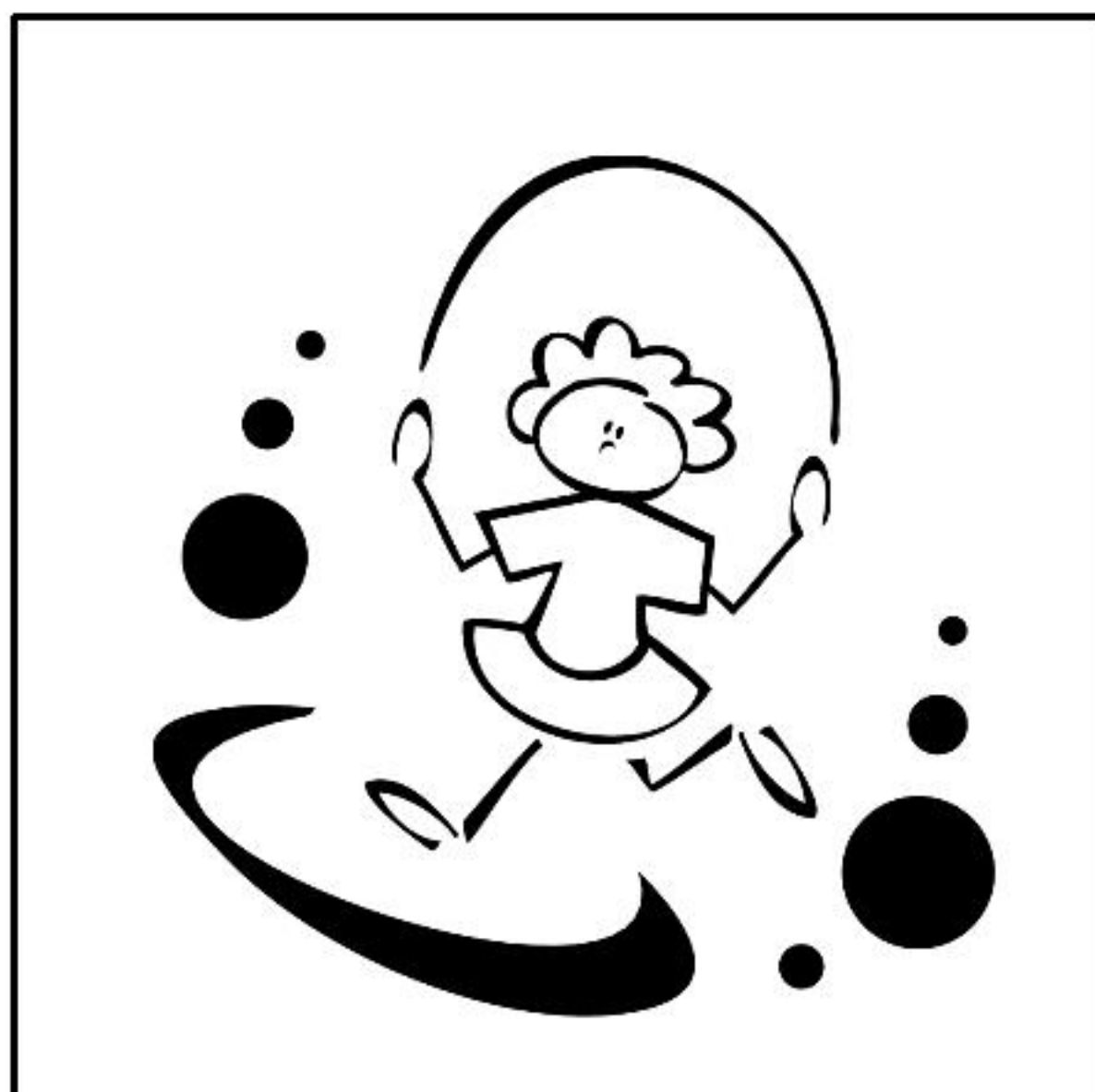

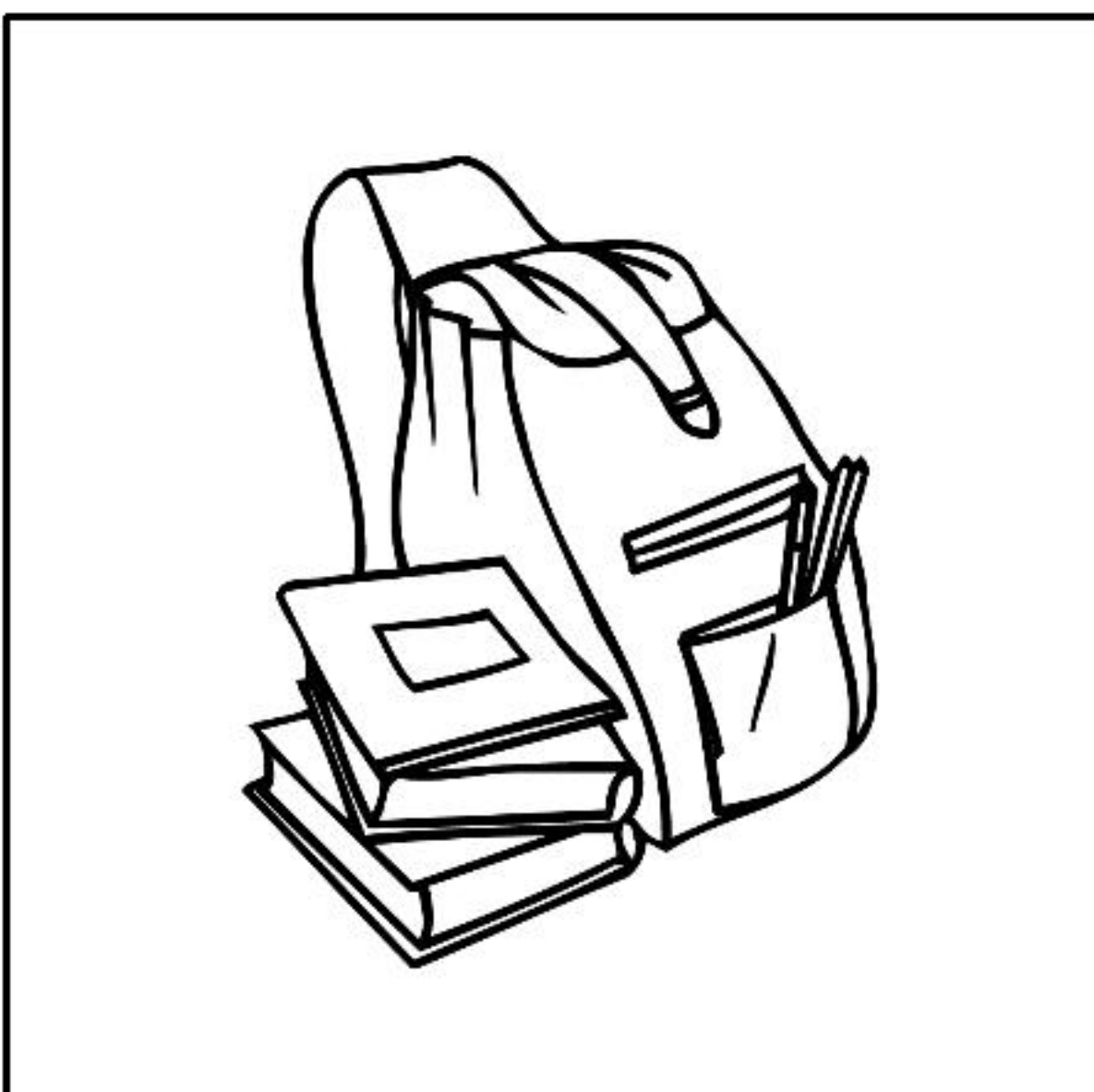
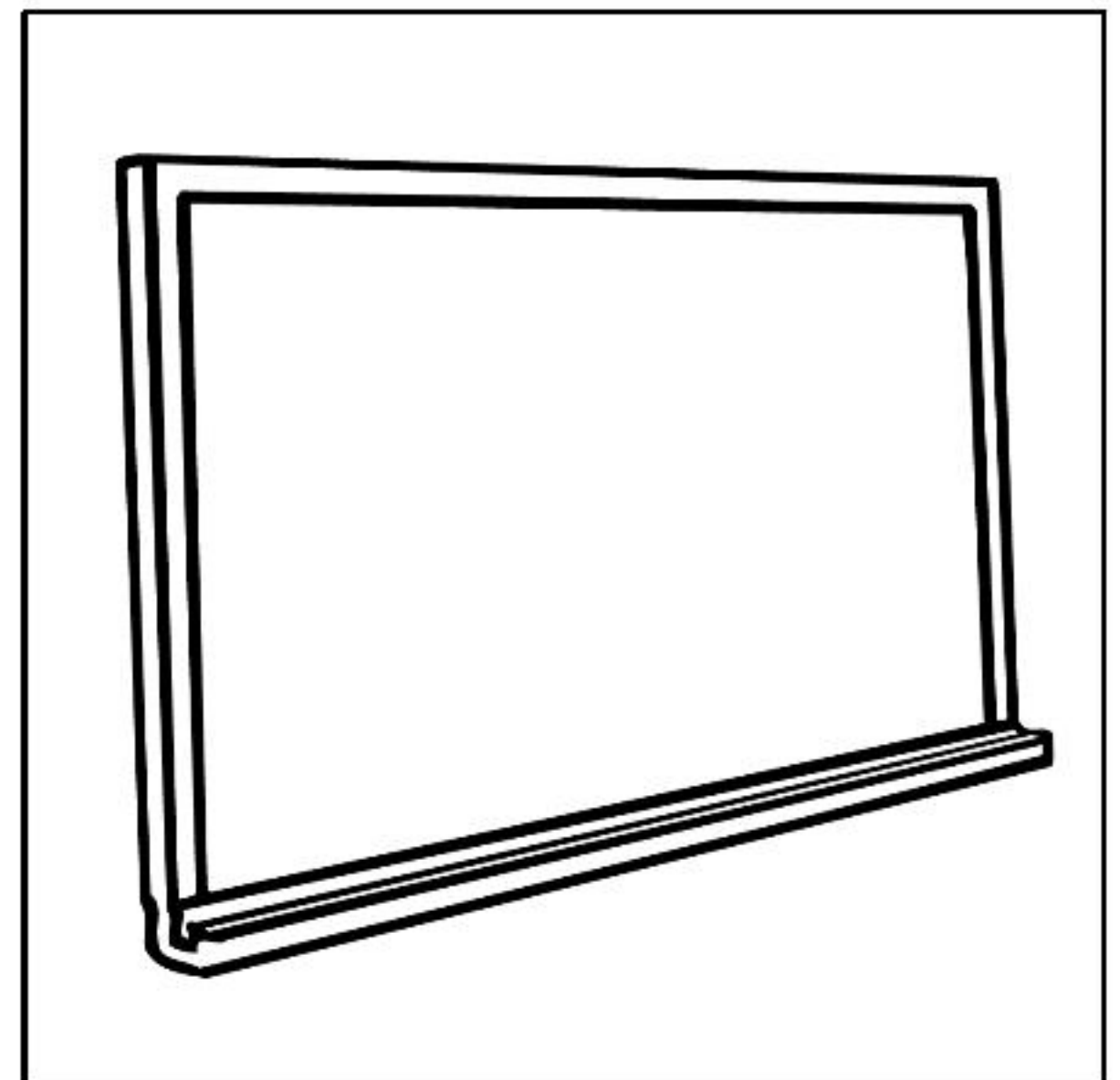
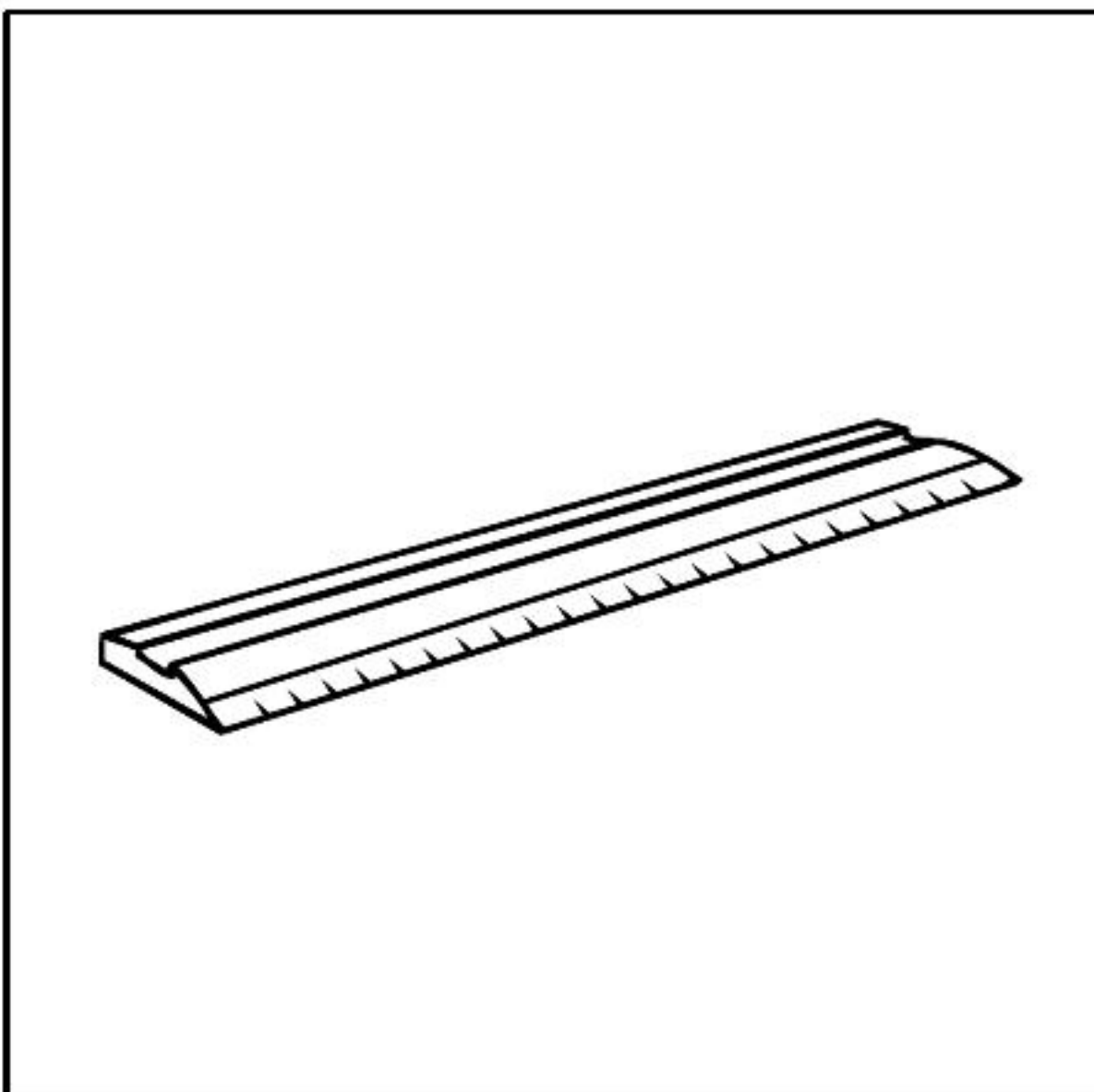
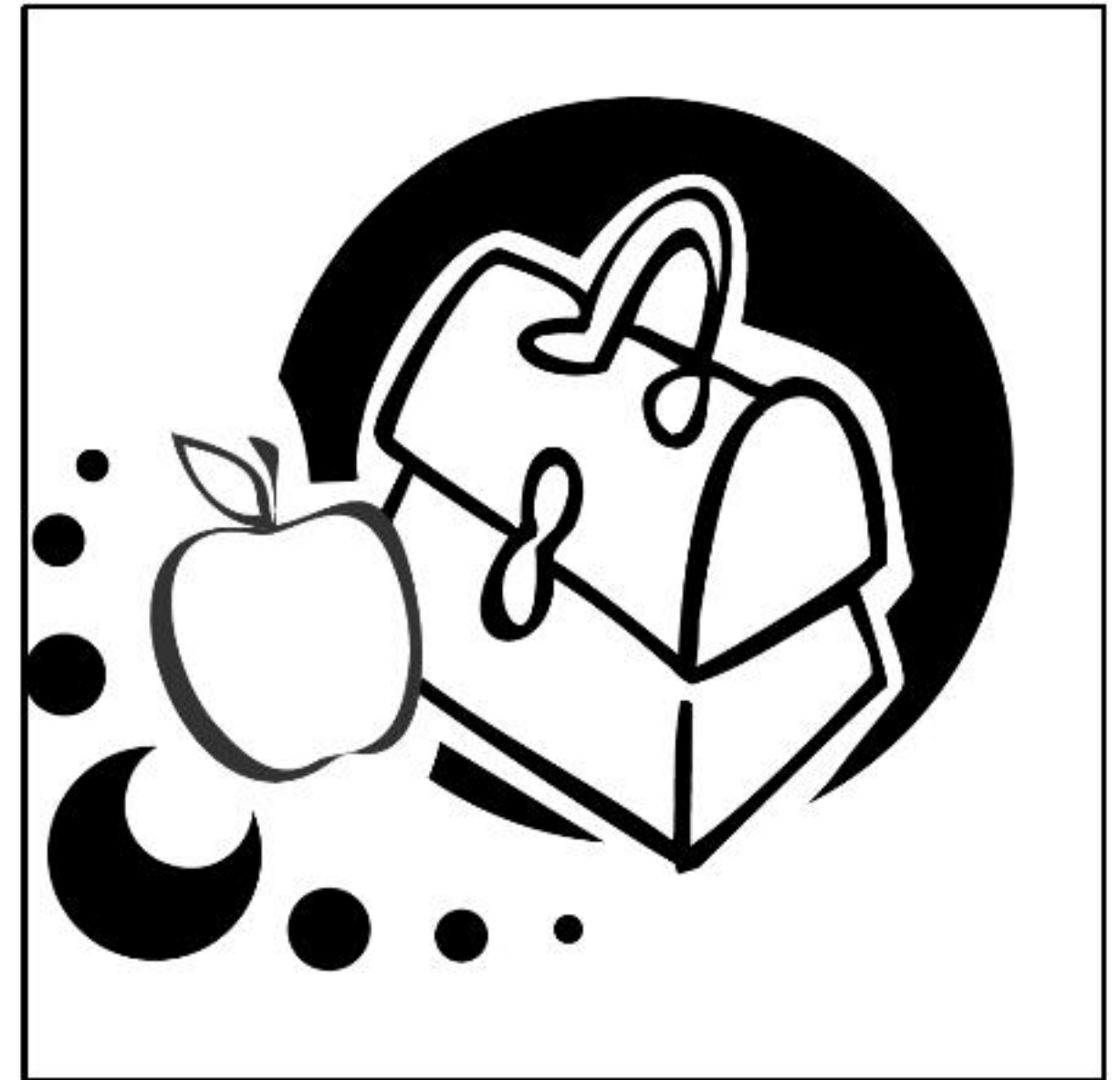
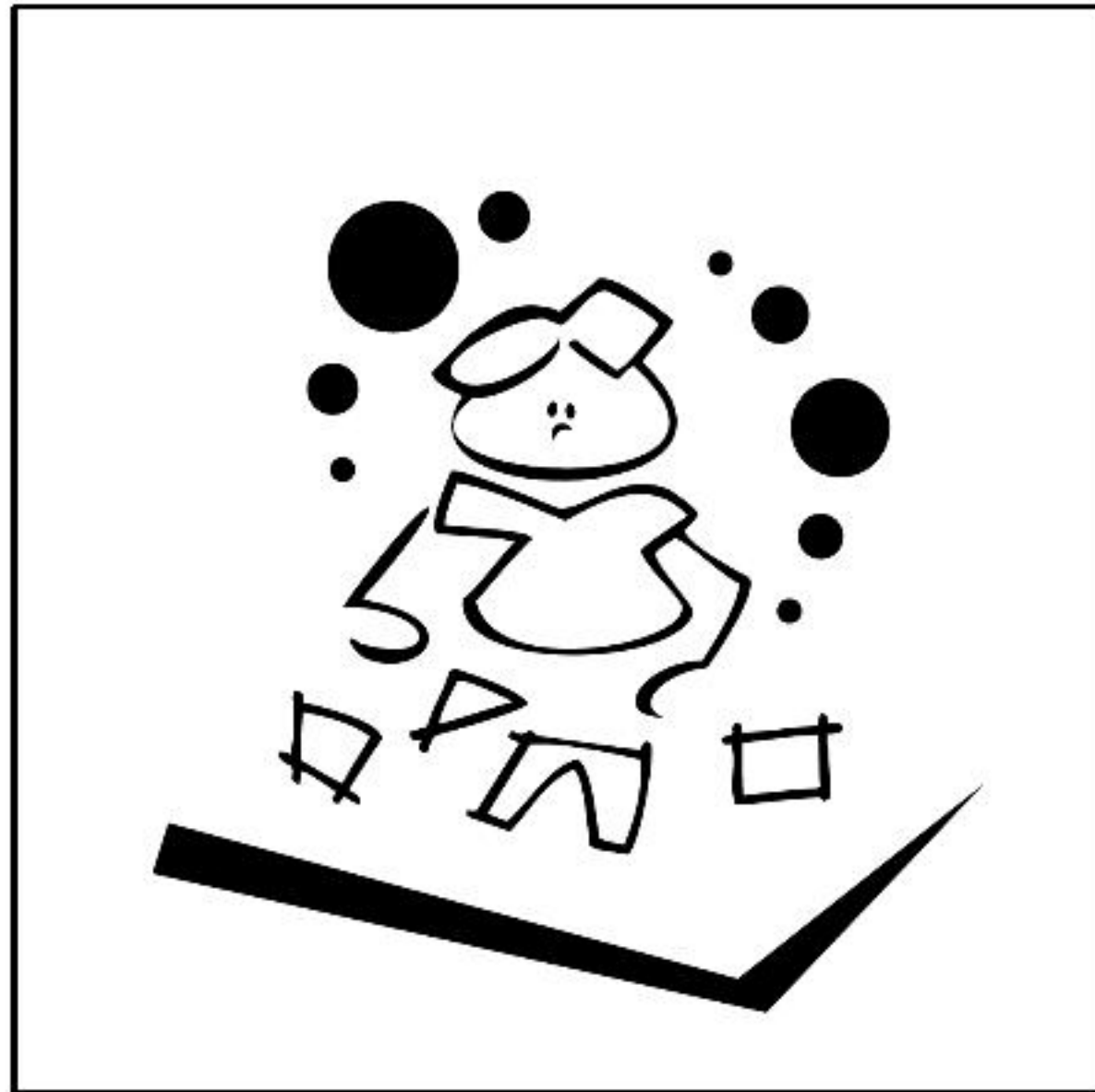
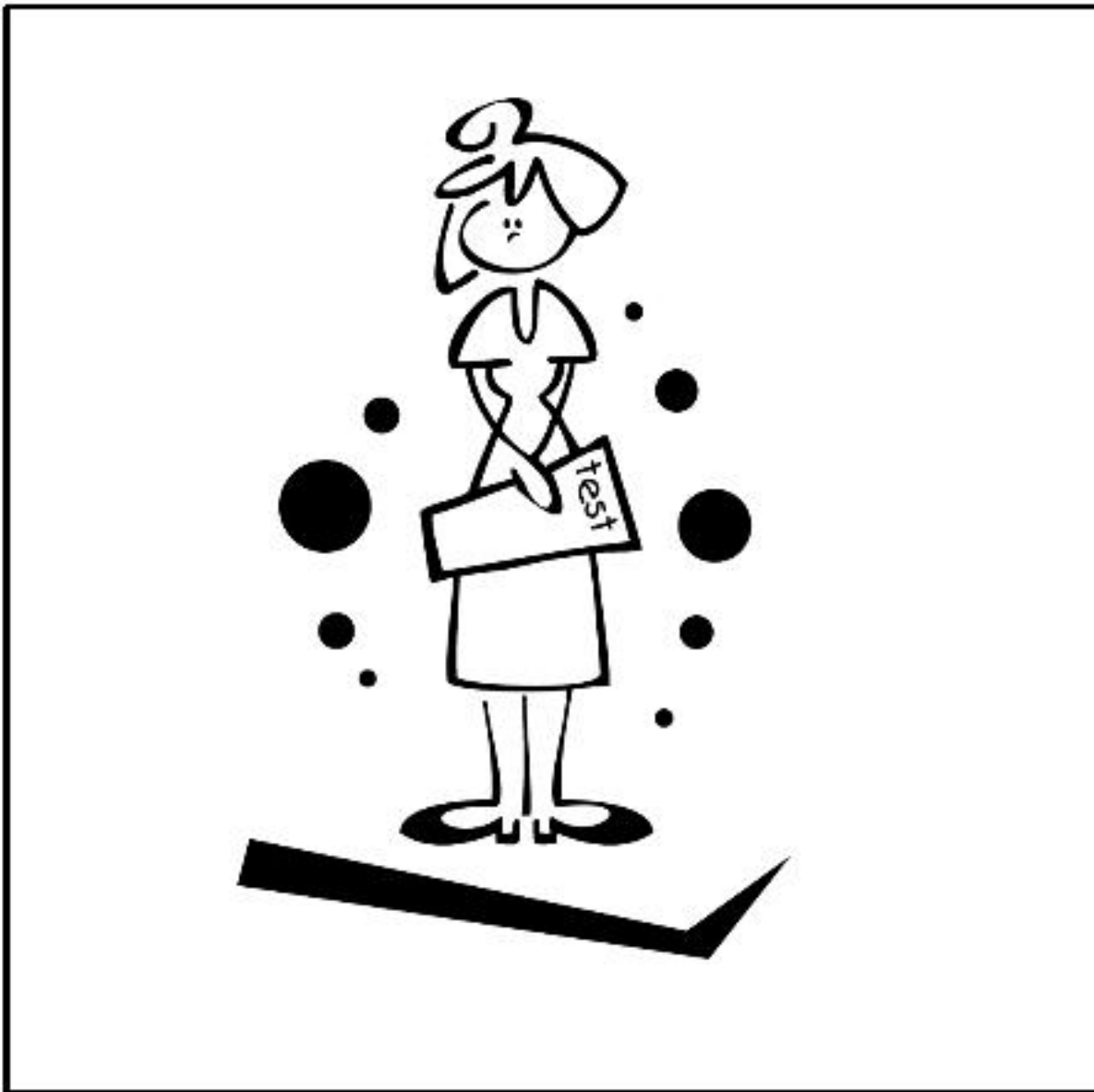
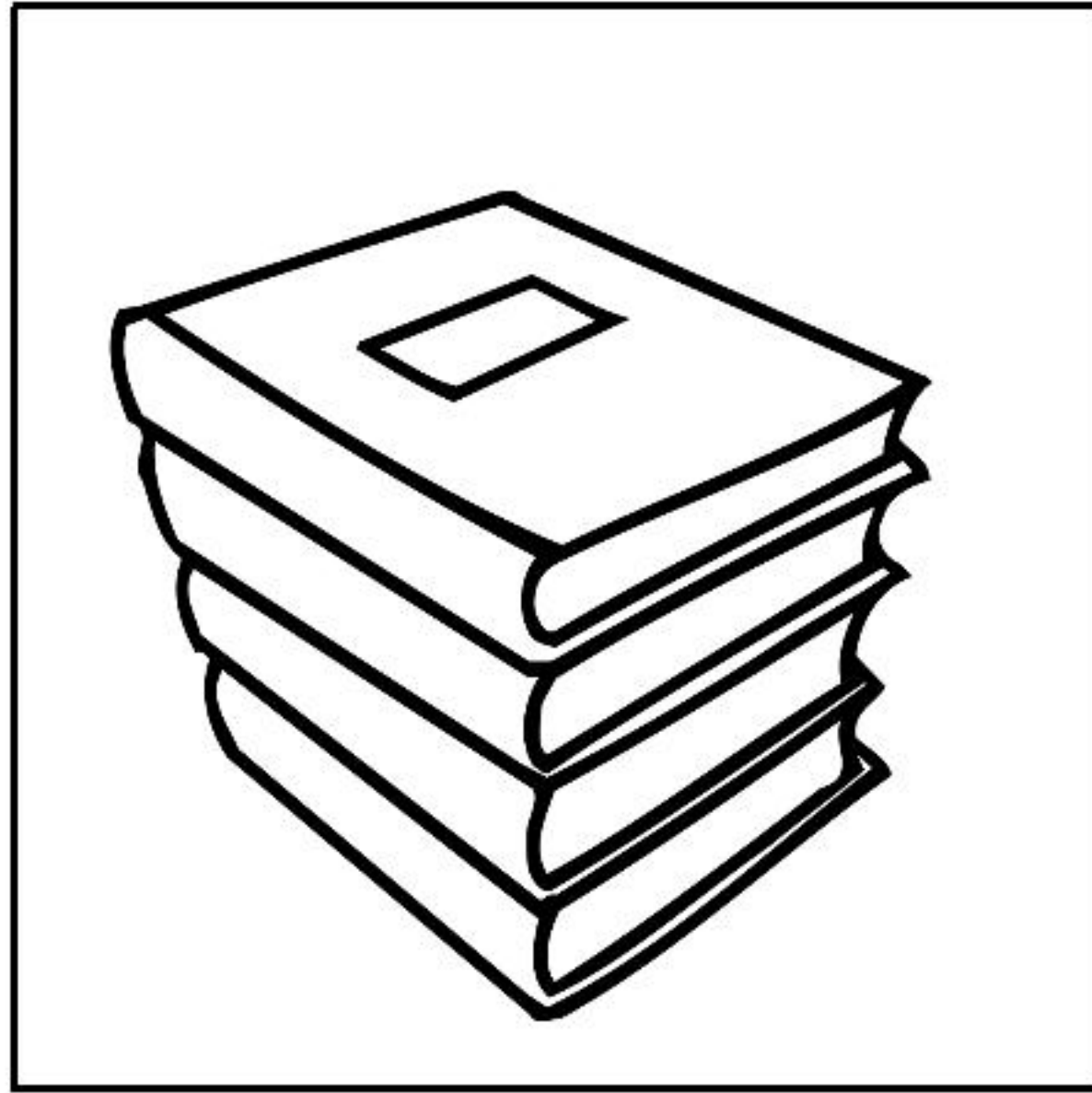
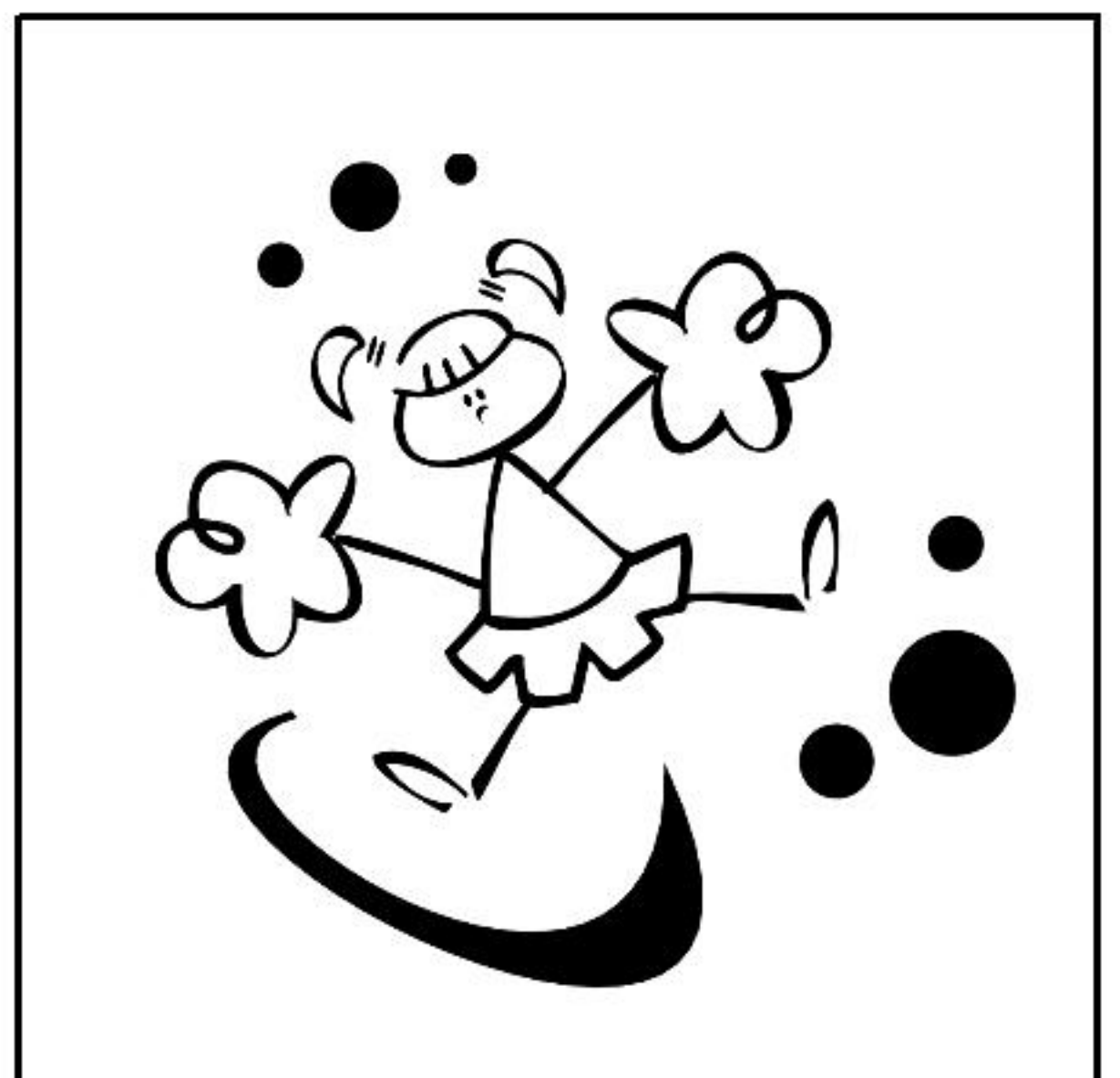
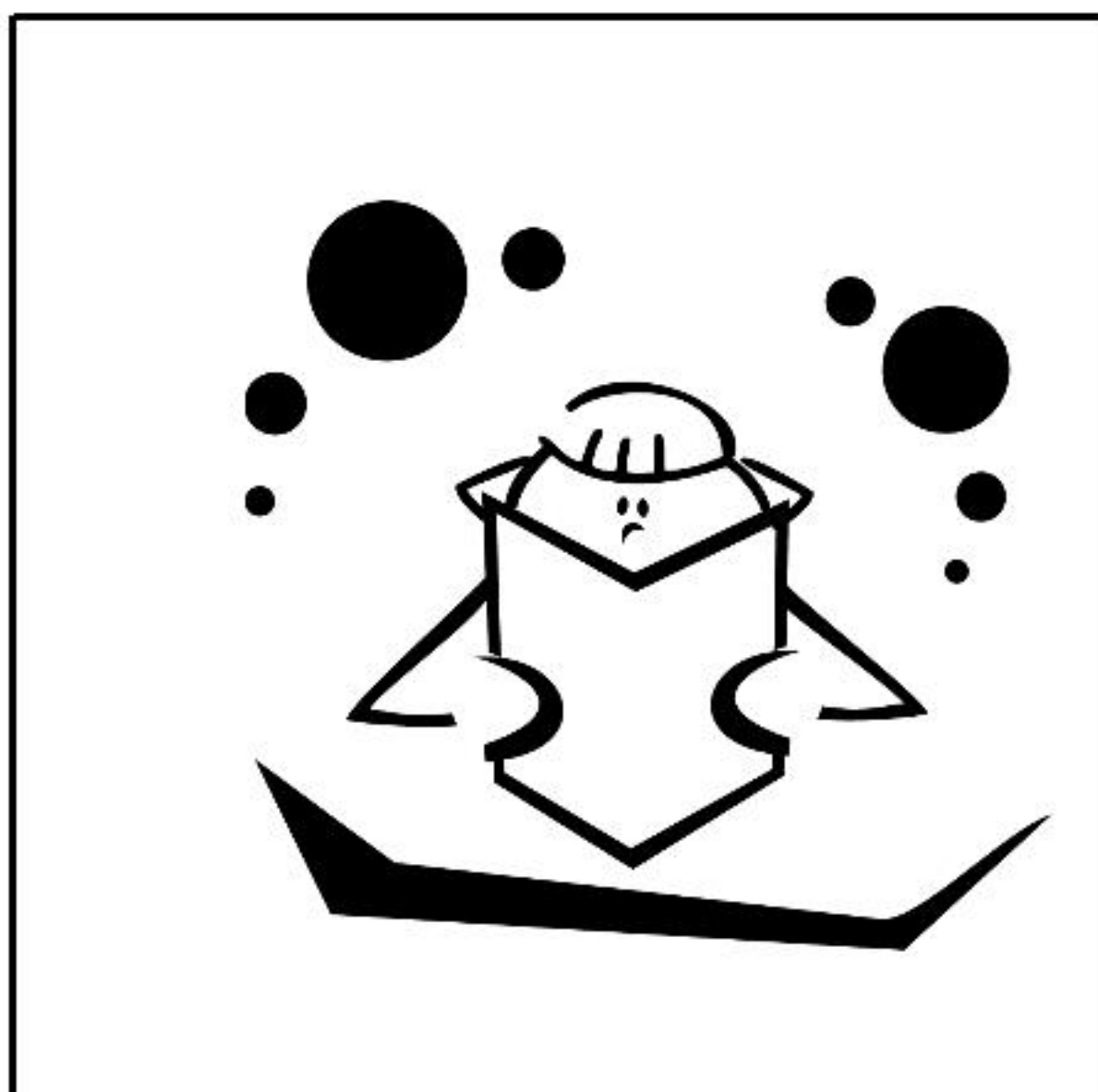
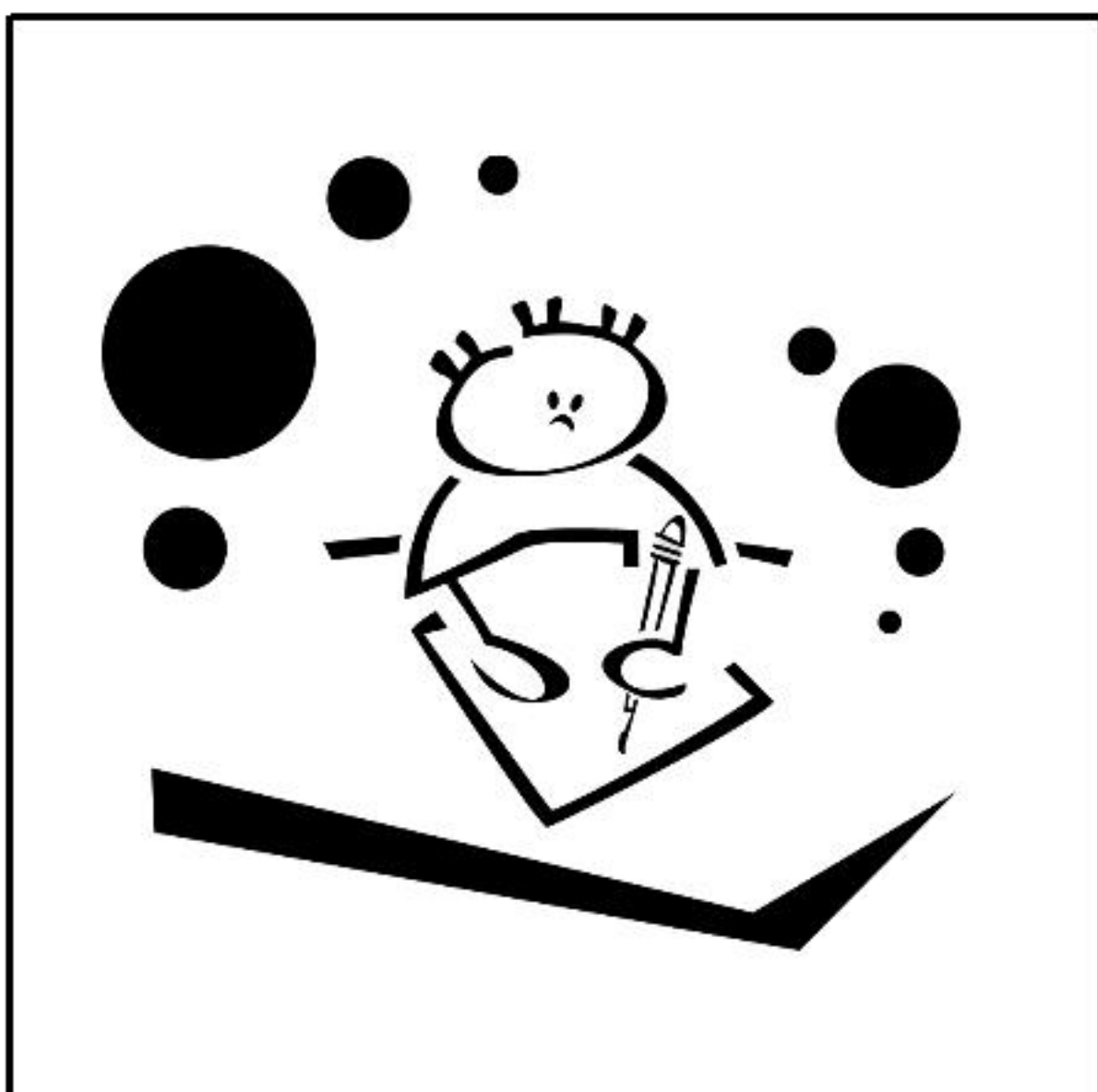
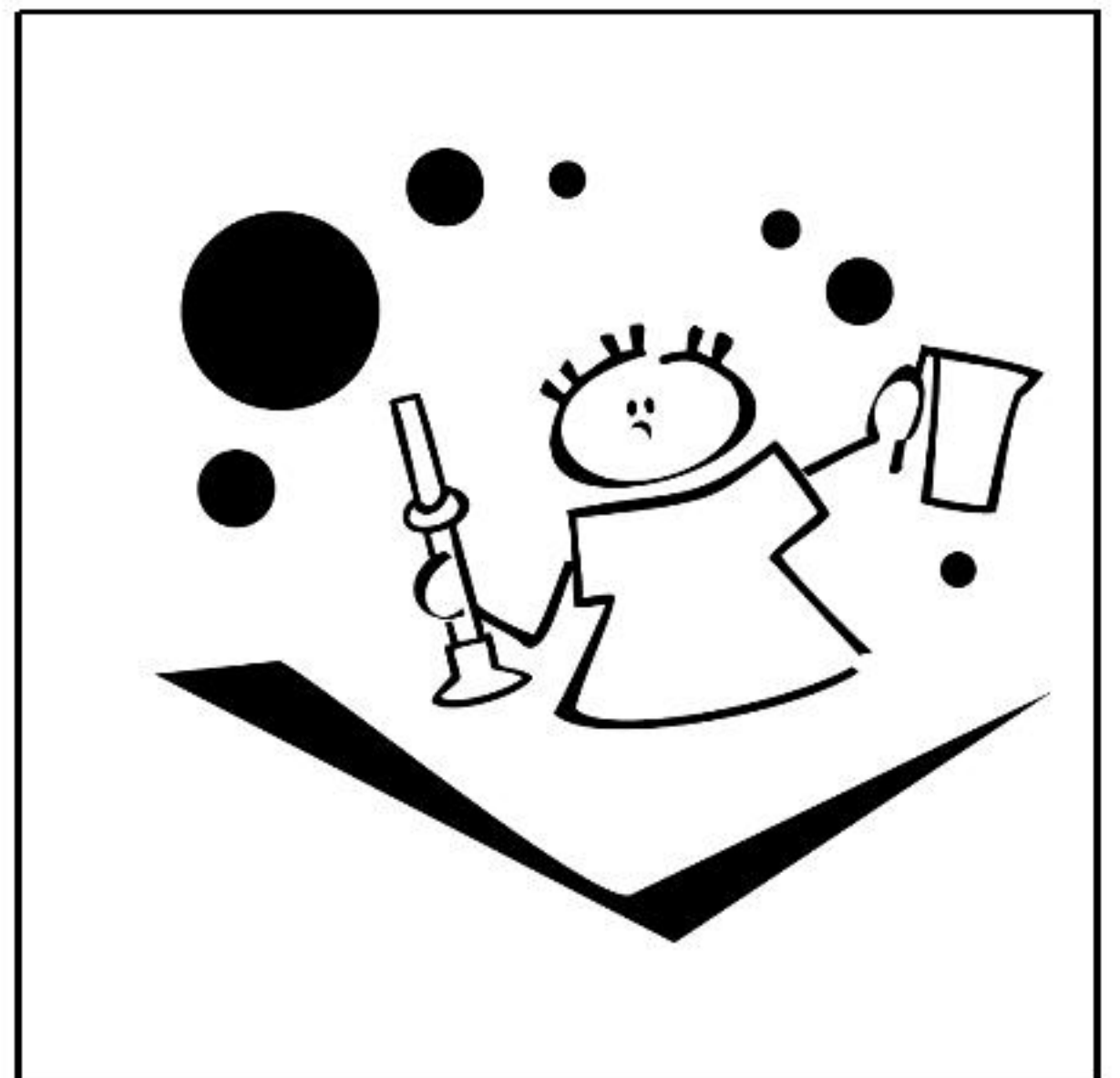
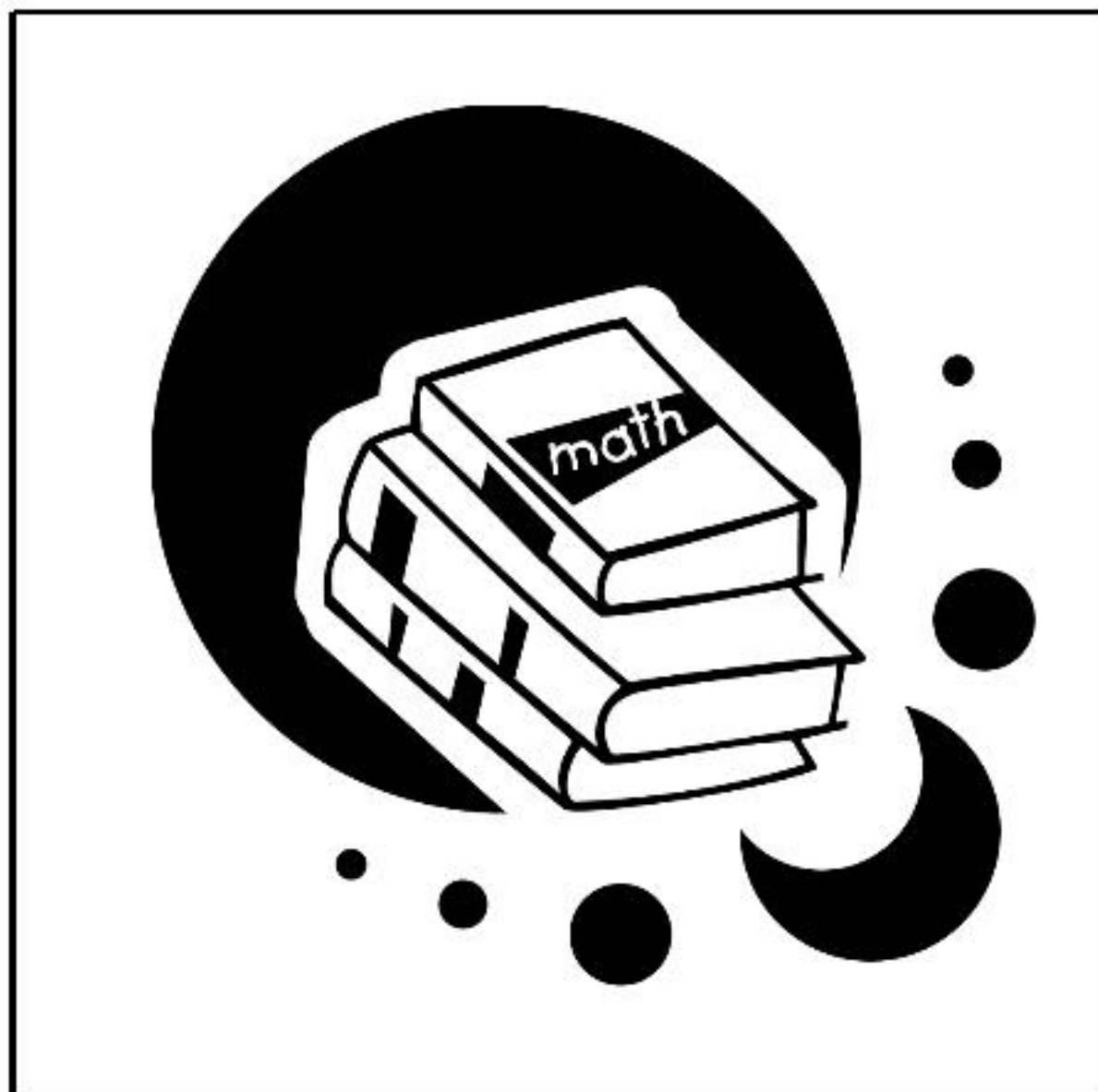
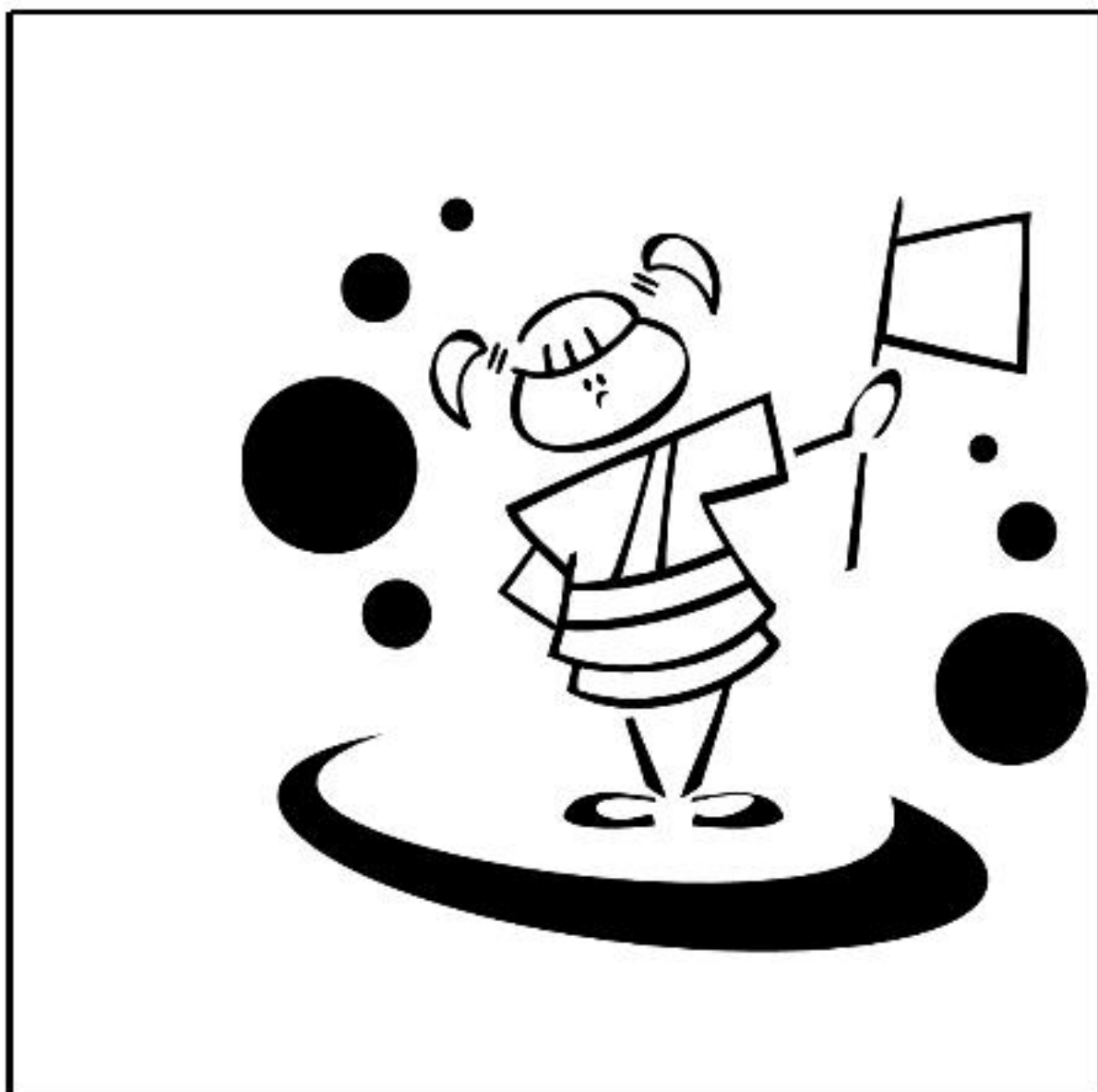
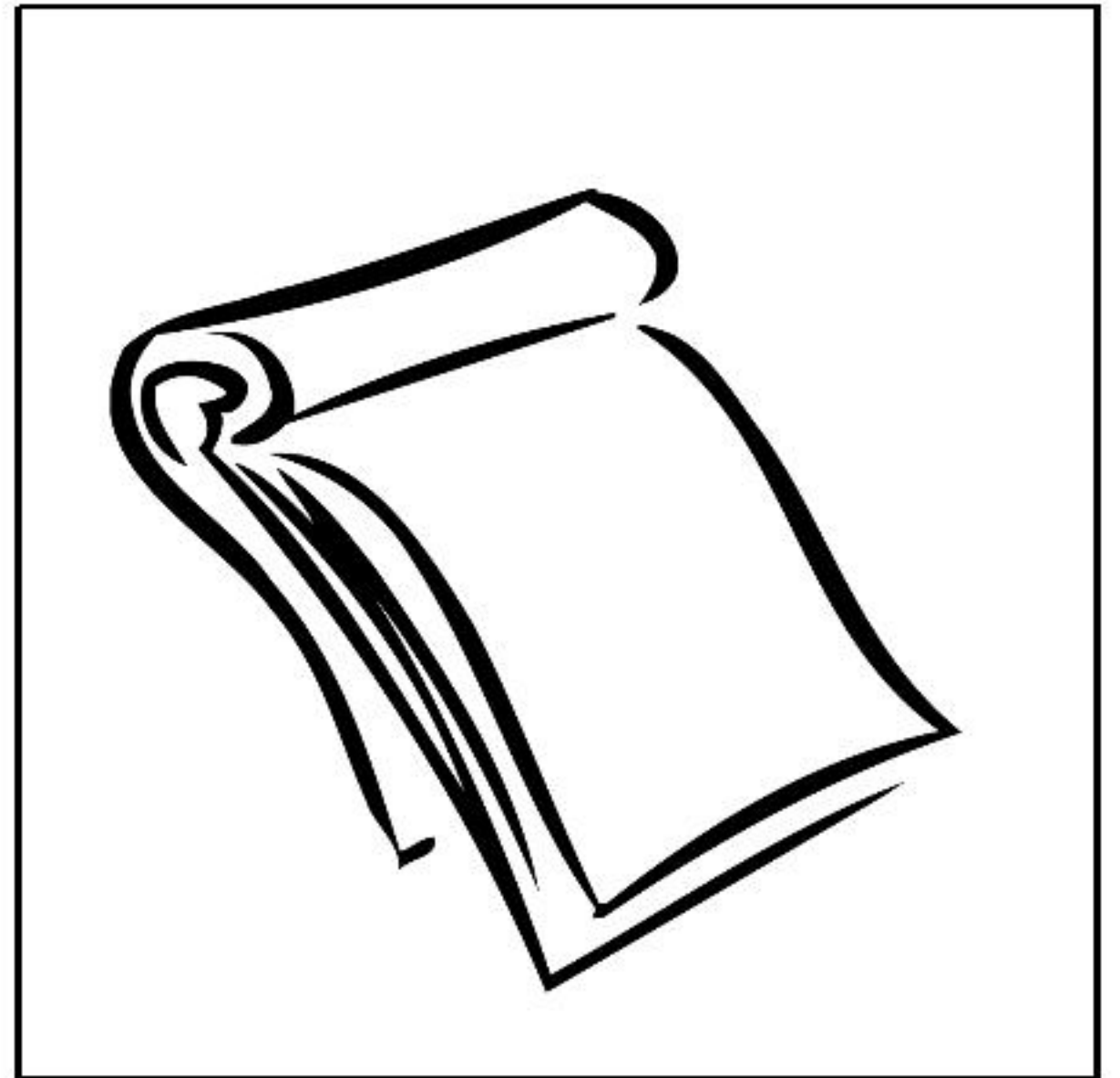
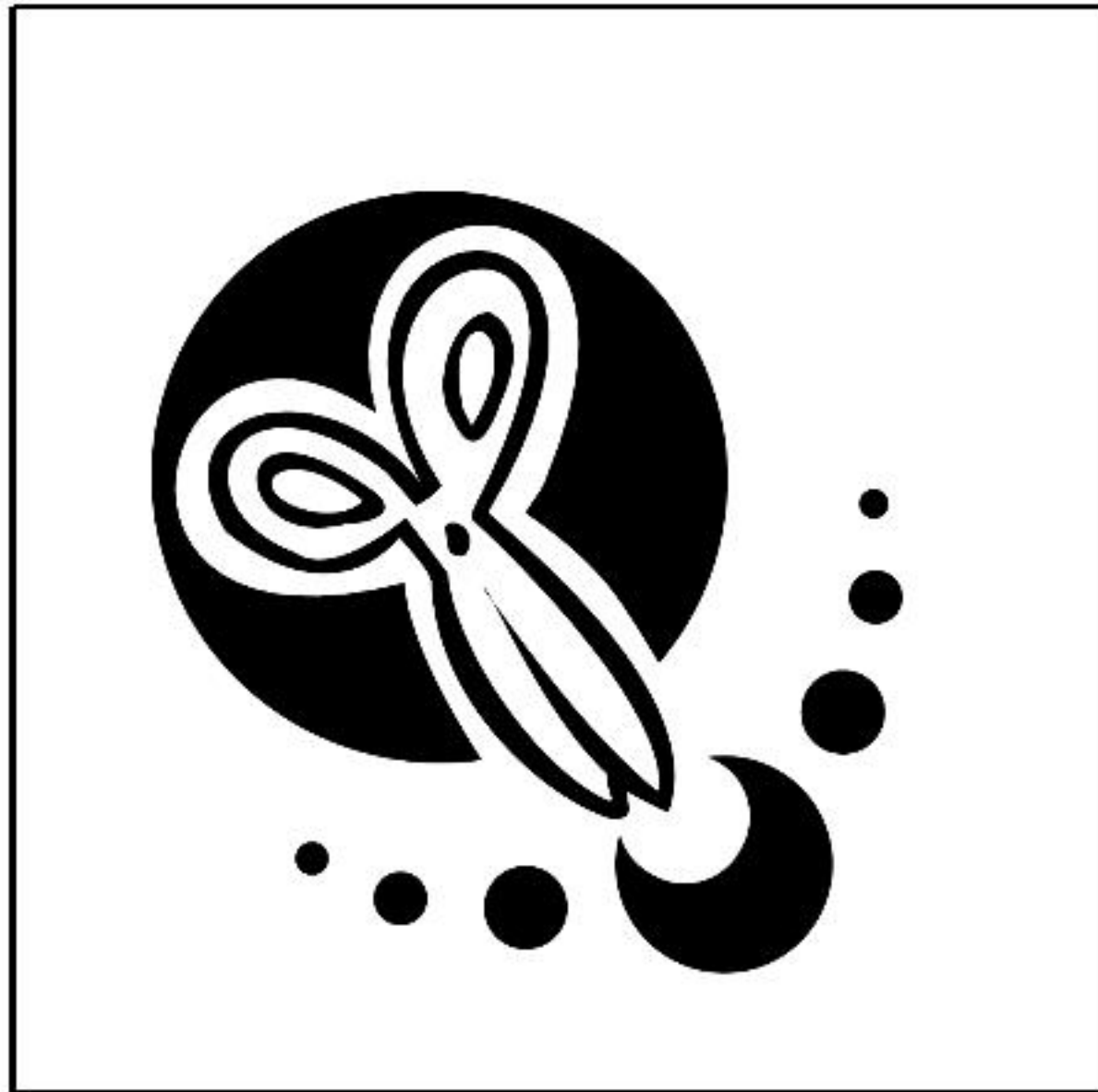
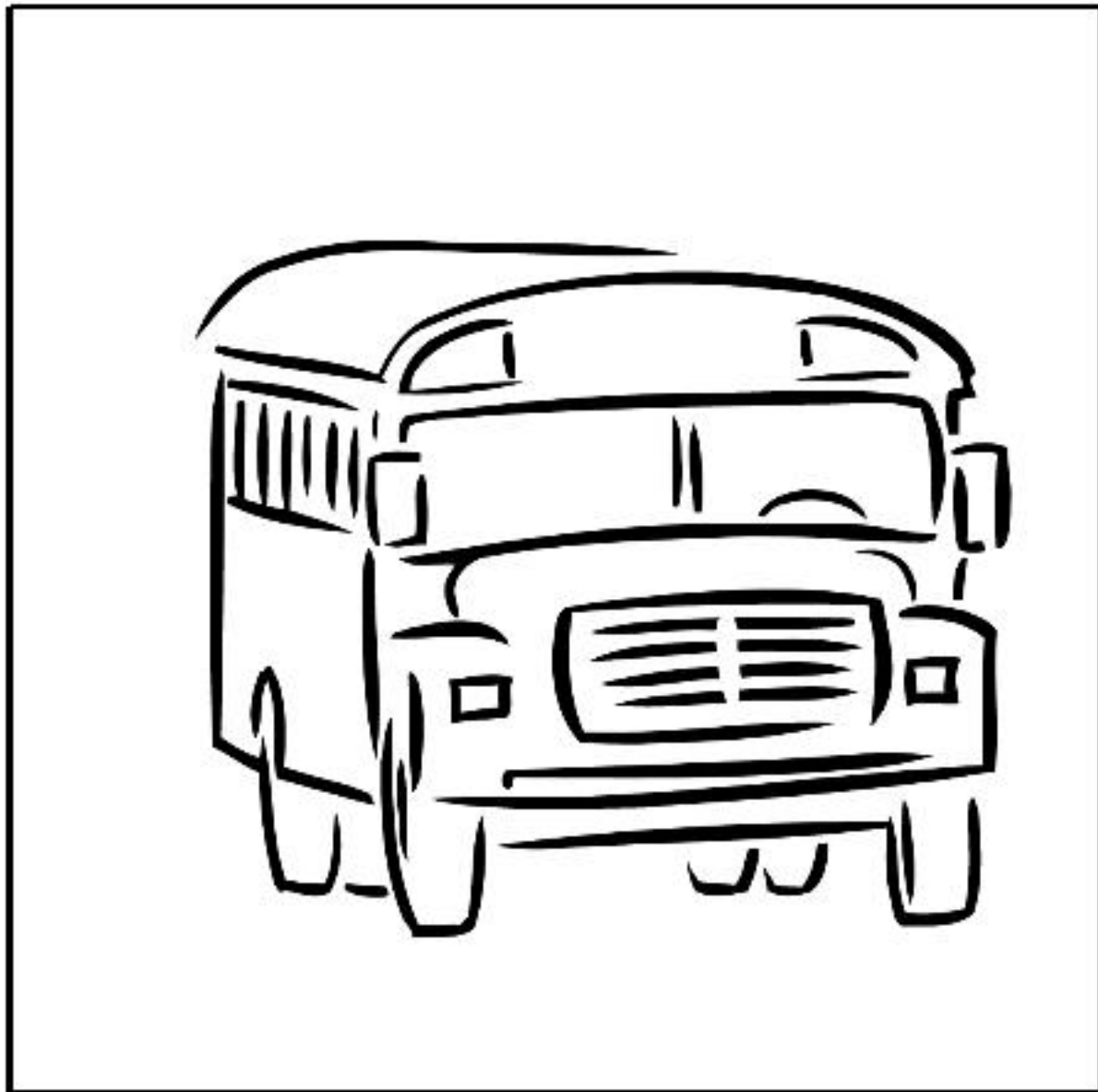
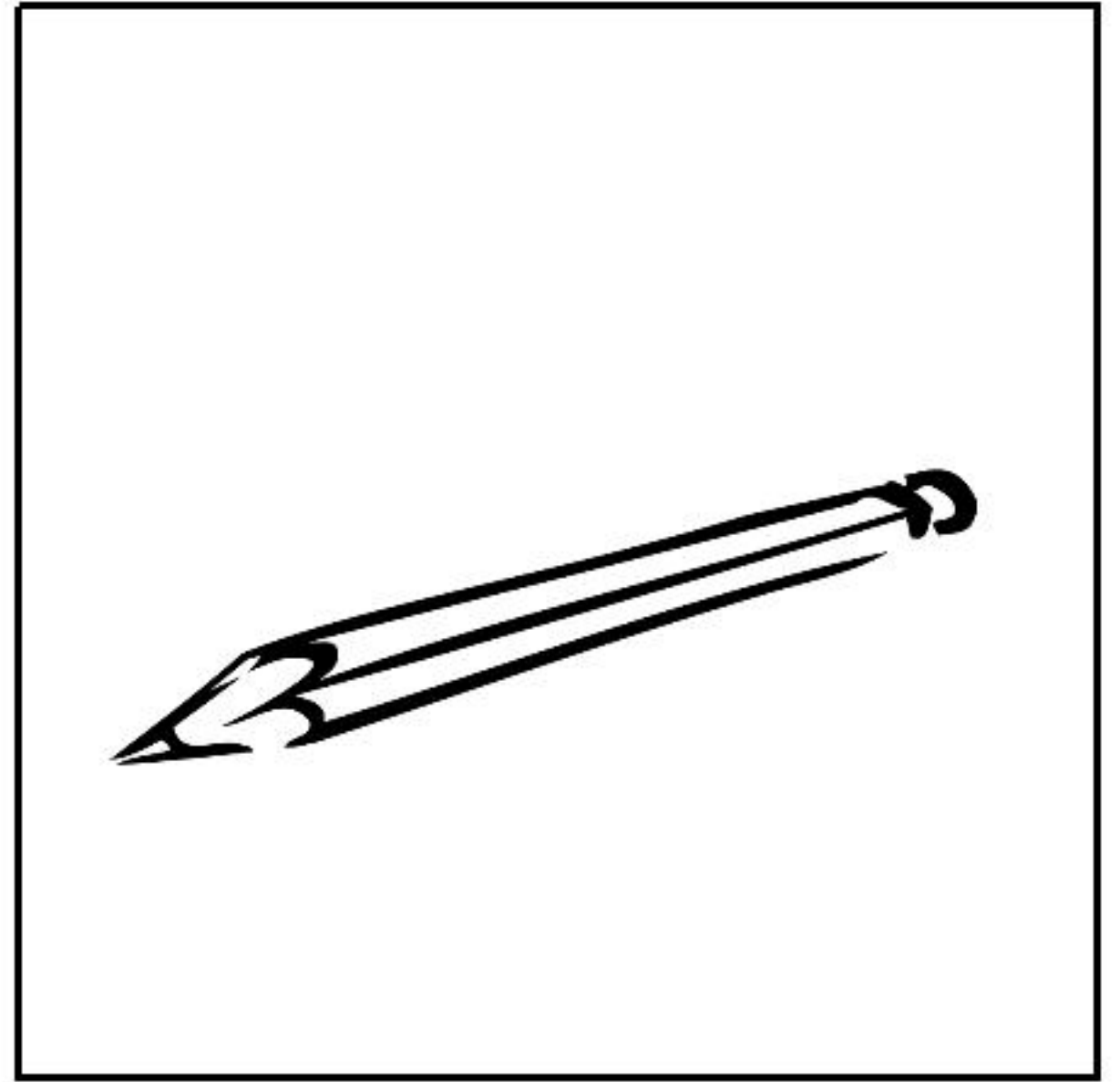
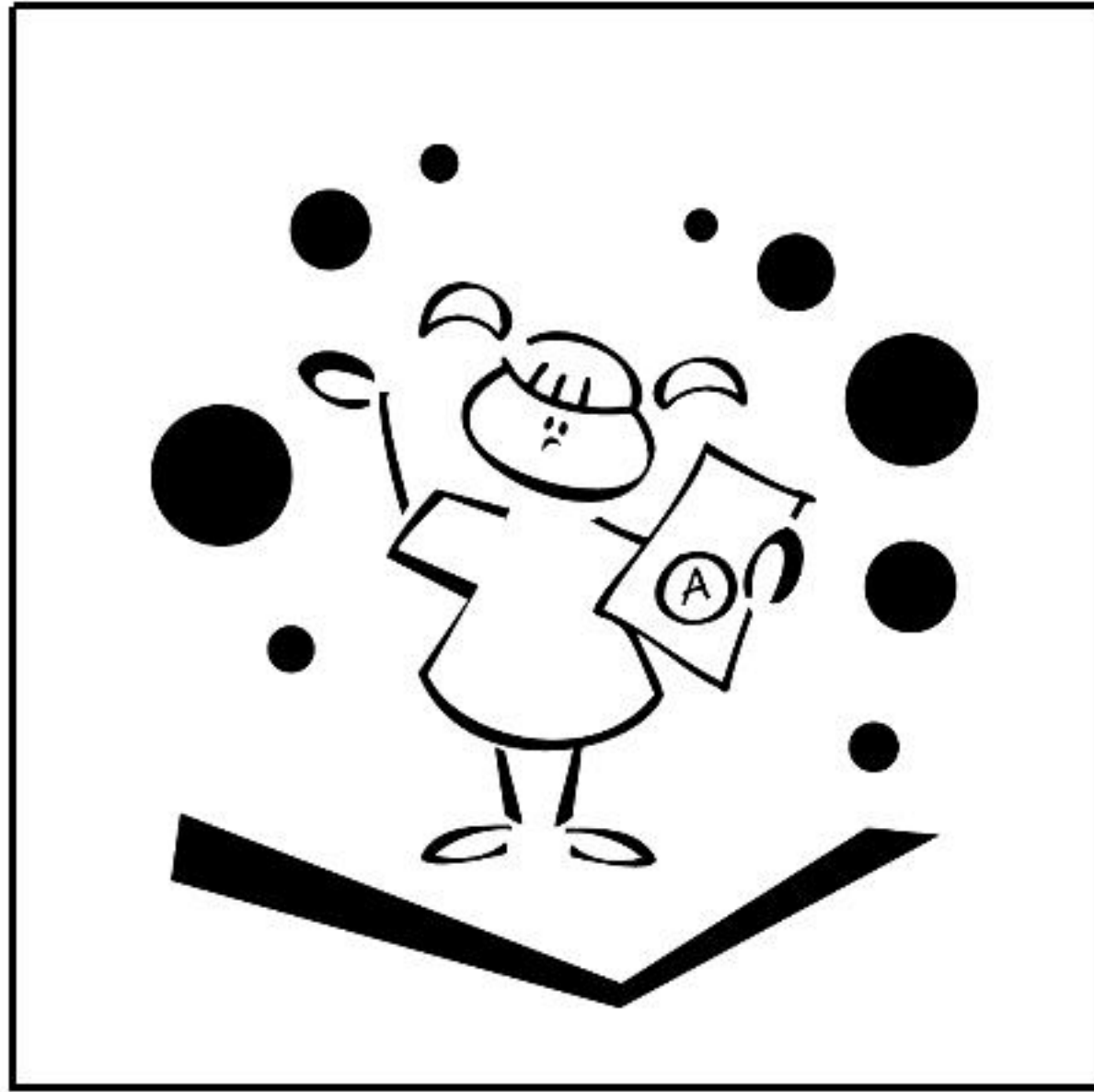

Cut and Paste Back to School

